

Omni Stone

Porcelain Stone



Wall: DROIS 03 Matt

6 Colours / 2 Finishes / 6 Sizes / 1 Mosaic

Omni Stone is a state-of-the-art full-body porcelain tile range that combines outstanding technical properties with graphic nuances inspired by the subtlety of natural stone. Omni Stone delivers the timeless elegance of stone, along with the superior performance and practicality of modern porcelain tiles.



Wall (right) & Counter: DROIS 02 Matt
Wall (left) & Floor: DROIS 04 Matt



Floor: DROIS 04 Matt



Wall: DROIS 01 Matt & DROIS 04 Soft



DROIS 01



DROIS 03



DROIS 02



DROIS 05



DROIS 04



DROIS 06

Sizes

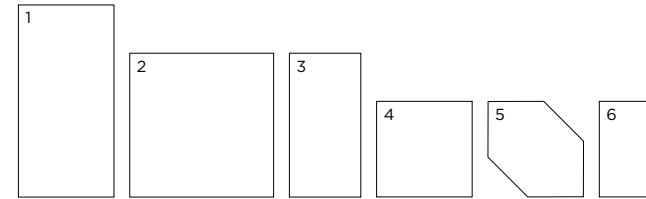

	Size (mm)	Thickness	Finish	Colour Availability
1	1186 x 592 (R)	9.8	Matt Soft	All colours All colours
2	889 x 889 (R)	10.5	Matt Soft	All colours All colours
3	889 x 443.5 (R)	10.5	Matt Soft	All colours All colours
4	592 x 592 (R)	9.8	Matt Soft	All colours All colours
5	Hexagon 592 x 592 (R)	9.8	Matt Soft	All colours All colours
6	592 x 295 (R)	9.8	Matt Soft	All colours All colours

(R) Rectified size - square edge with bevel. Mosaics shown on next page.
Swatch colours may vary from original. Samples should be requested.

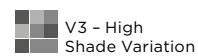

Multi Mosaic



DROIS 01 Multi Mosaic



DROIS 03 Multi Mosaic



DROIS 02 Multi Mosaic



DROIS 05 Multi Mosaic

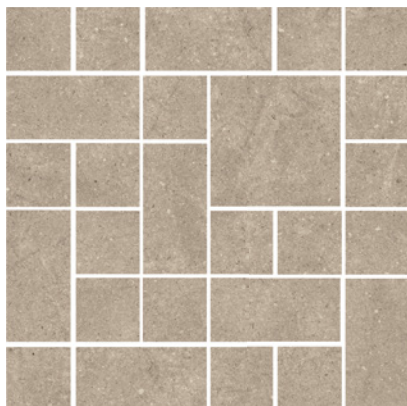

DROIS 04 Multi Mosaic

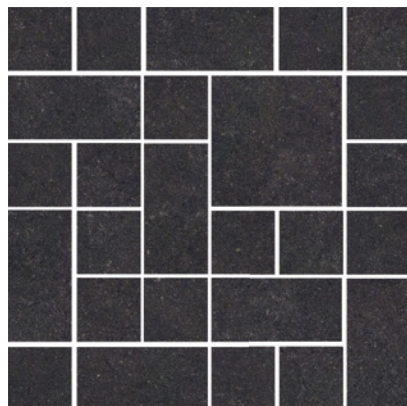

DROIS 06 Multi Mosaic

Mosaics

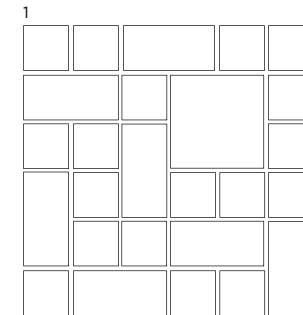

	Size (mm)	Thickness	Finish	Colour Availability
1	Multi Mosaic on 295 x 295 sheet	9.8	Matt	All colours

Swatch colours may vary from original. Samples should be requested.
Special pieces shown on next page.

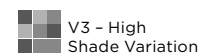

V3 - High
Shade Variation

DOMUS

service@domusgroup.com | t: 020 8481 9500 | domusgroup.com



Wall (right) & Counter: DROIS O2 Matt
Wall (left) & Floor: DROIS O4 Matt

Special Pieces

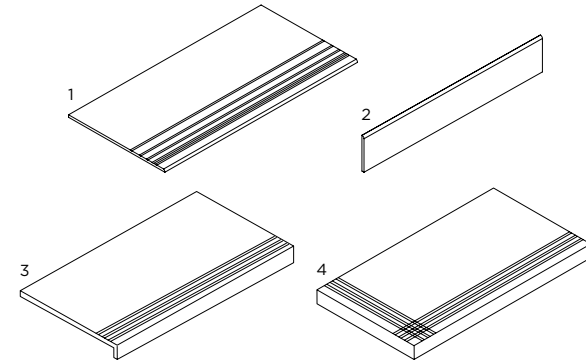

	Size (mm)	Thickness	Finish	Colour Availability
1	Grooved Step Tread			
	1186 x 592 (R)	9.8	All finishes	All colours
	1186 x 295 (R)	9.8	All finishes	All colours
	889 x 443.5 (R)	10.5	All finishes	All colours
	592 x 592 (R)	9.8	All finishes	All colours
2	592 x 295 (R)	9.8	All finishes	All colours
	Plinth Skirting			
	1186 x 80 (R)	9.8	All finishes	All colours
	889 x 80 (R)	10.5	All finishes	All colours
3	592 x 80 (R)	9.8	All finishes	All colours
	443.5 x 80 (R)	10.5	All finishes	All colours
	Bullnose Step Tread	9.8	All finishes	All colours
4	592 x 295 (R)			
	Angle Step Tread	9.8	All finishes	All colours

Swatch colours may vary from original. Samples should be requested.
Angle Step Tread available in left and right corner pieces.

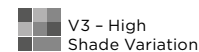

DOMUS

Omni Stone

Technical Data

Product Type: Unglazed Porcelain (BS EN 14411 - Group Bla)

Use: Internal & External Floors & Walls

Product Code: DROIS

DIMENSION & SURFACE QUALITY

Technical Characteristics	Industry Standards	Requirement	Actual Value
Length & width	BS EN ISO 10545-2	± 0.60% (max. ± 2.0mm)	Conforms
Thickness	BS EN ISO 10545-2	± 5% (max. ± 0.5mm)	Conforms
Edge straightness	BS EN ISO 10545-2	± 0.50% (max. ± 1.5mm)	Conforms
Orthogonality (squareness)	BS EN ISO 10545-2	± 0.50% (max. ± 2.0mm)	Conforms
Planarity (flatness)	BS EN ISO 10545-2	± 0.50% (max. ± 2.0mm)	Conforms
Appearance	BS EN ISO 10545-2	> 95%	Conforms

SLIP RESISTANCE

Technical Characteristics	Industry Standards	Requirement	Finish
Areas with footwear	BS EN ISO 10545-17 (DIN 51130)	R10 from 10° to 19°	Matt
Areas with bare feet	DIN 51097	B over 18° to 24°	Matt
Slip resistance Coefficient of friction	BS 7976-2 BS EN 16165	Test results upon request	

PRODUCT QUALITY & DURABILITY

Technical Characteristics	Industry Standards	Requirement	Actual Value
Water absorption	BS EN ISO 10545-3	≤ 0.5%	Conforms
Modulus of rupture (bending strength)	BS EN ISO 10545-4	≥ 35 N/mm ²	> 45 N/mm ² (Typical value)
Breaking strength	BS EN ISO 10545-4	≥ 7.5mm ≥ 1300 N	> 3500 N (Typical value)
Resistance to deep abrasion (unglazed tiles)	BS EN ISO 10545-6	≤ 175 mm ³	< 120 mm ³
Linear thermal expansion coefficient	BS EN ISO 10545-8	Declared value	≤ 8.0x10 ⁻⁶ /°C (Typical value)
Thermal shock resistance	BS EN ISO 10545-9	No visible defects	Resistant
Frost resistance	BS EN ISO 10545-12	No surface alteration	Resistant
Chemical resistance: Low concentrations of acids & alkalis	BS EN ISO 10545-13	No visible defects	ULA
High concentrations of acids & alkalis	BS EN ISO 10545-13	No visible defects	UHA
Domestic chemicals & additives for swimming pools	BS EN ISO 10545-13	UB/GB min.	UA
Stain resistance	BS EN ISO 10545-14	Declared value - unglazed	Class 5
Reaction to fire	Based on the decision 96/603/EC and its changes	A1 _{FL} /A1	A1 _{FL} /A1
Recycled content			0%



All test results are based upon current test data provided by the manufacturer and are provided in good faith. Domus Group cannot be held responsible for any variation in the test data due to changes in manufacture or material characteristics. Errors & omissions excepted. Please refer to Domus Group Terms & Conditions of Sale. Dec. 2020

DOMUS

service@domusgroup.com | t: 020 8481 9500 | domusgroup.com